

# HYPE FL-C 123-Z

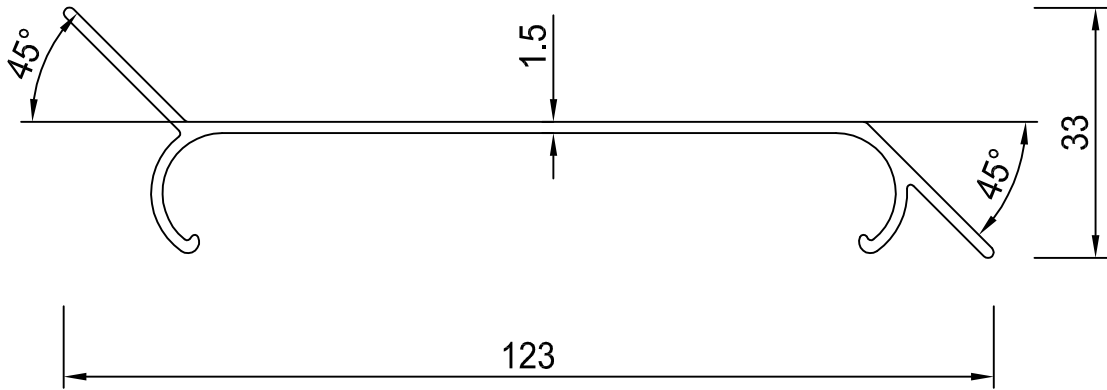

Bezeichnung	Fassadenlamelle
Typ	FL-C 123-Z
Profilnummer	6341
Toleranz	EN 755-9
Abwicklung	0,335 m
Ix	0,876 cm <sup>4</sup>
Iy	40,907 cm <sup>4</sup>
Material	AlMgSi0,5 (EN AW6060-T66)
Oberfläche	roh / RAL / Eloxal / Nasslack

Anwendung unter 45° Neigung, M1:2

