

Optional: Enddeckel
 Verschraubung 2,9x13

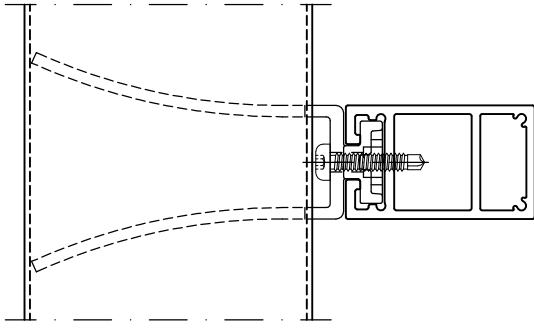

Lamelle	FL-C 100
Aufbau	FL-P 50x30 mit LH45-100
Material	EN AW-6060-T66 (AlMgSi0,5)
Oberfläche	roh / RAL / Eloxal / Nasslack

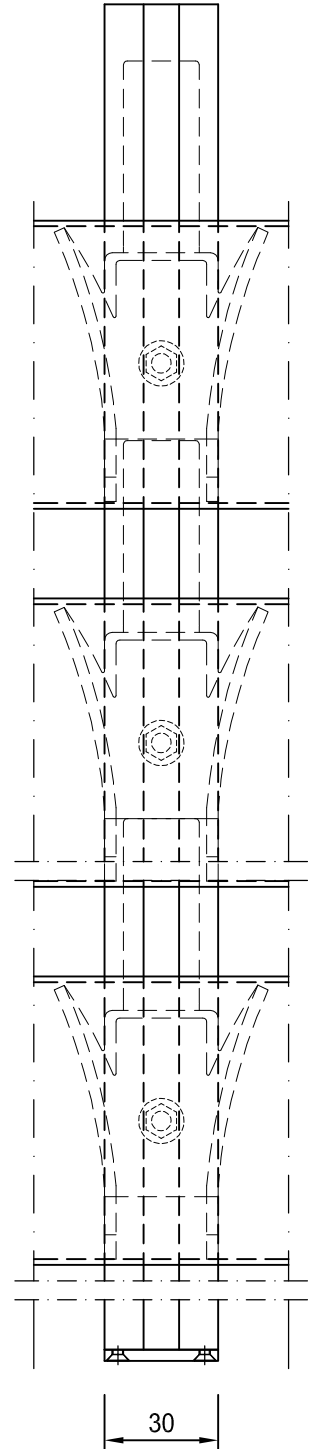

M 1:2