

HYPE FL-C 140-Z

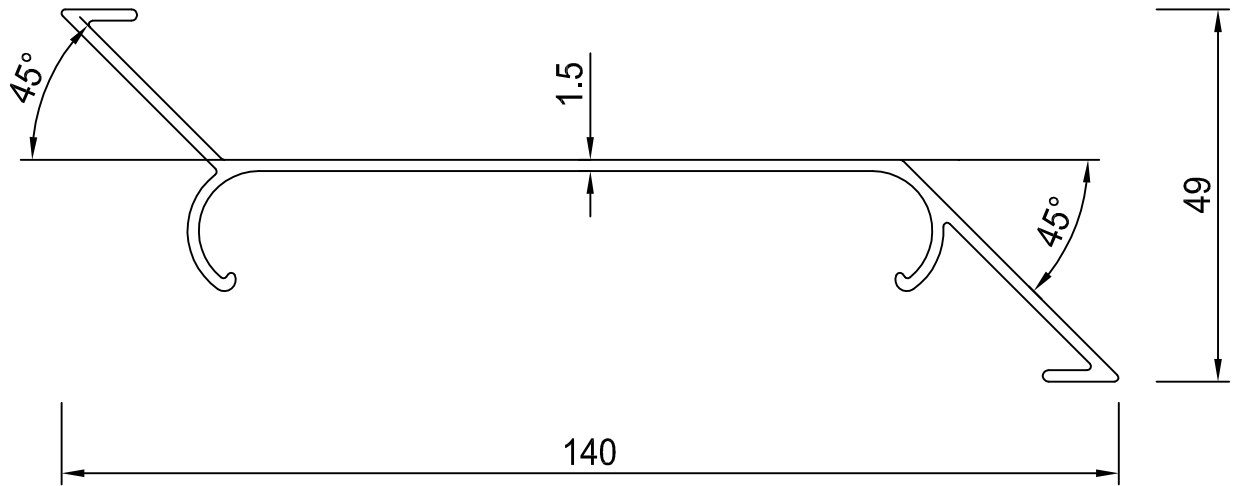

Bezeichnung	Fassadenlamelle
Typ	FL-C 140-Z
Profilnummer	6451
Toleranz	EN 755-9
Abwicklung	0,409 m
I _x	1,887 cm ⁴
I _y	67,533 cm ⁴
Material	AlMgSi0,5 (EN AW6060-T66)
Oberfläche	roh / RAL / Eloxal / Nasslack

Anwendung unter 45° Neigung, M1:2

